

8x Oli 1x2

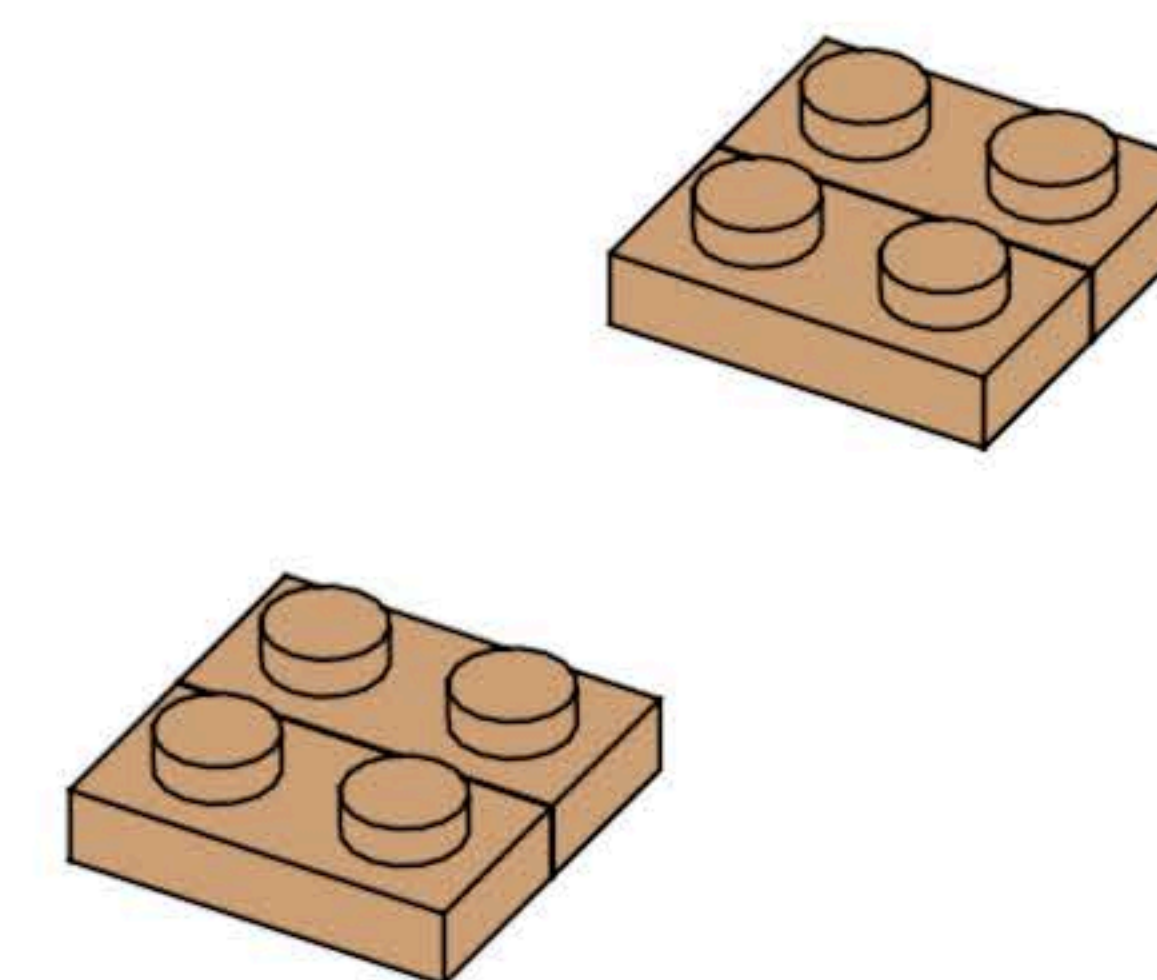

4× Max 2×2

8× Lox-Max

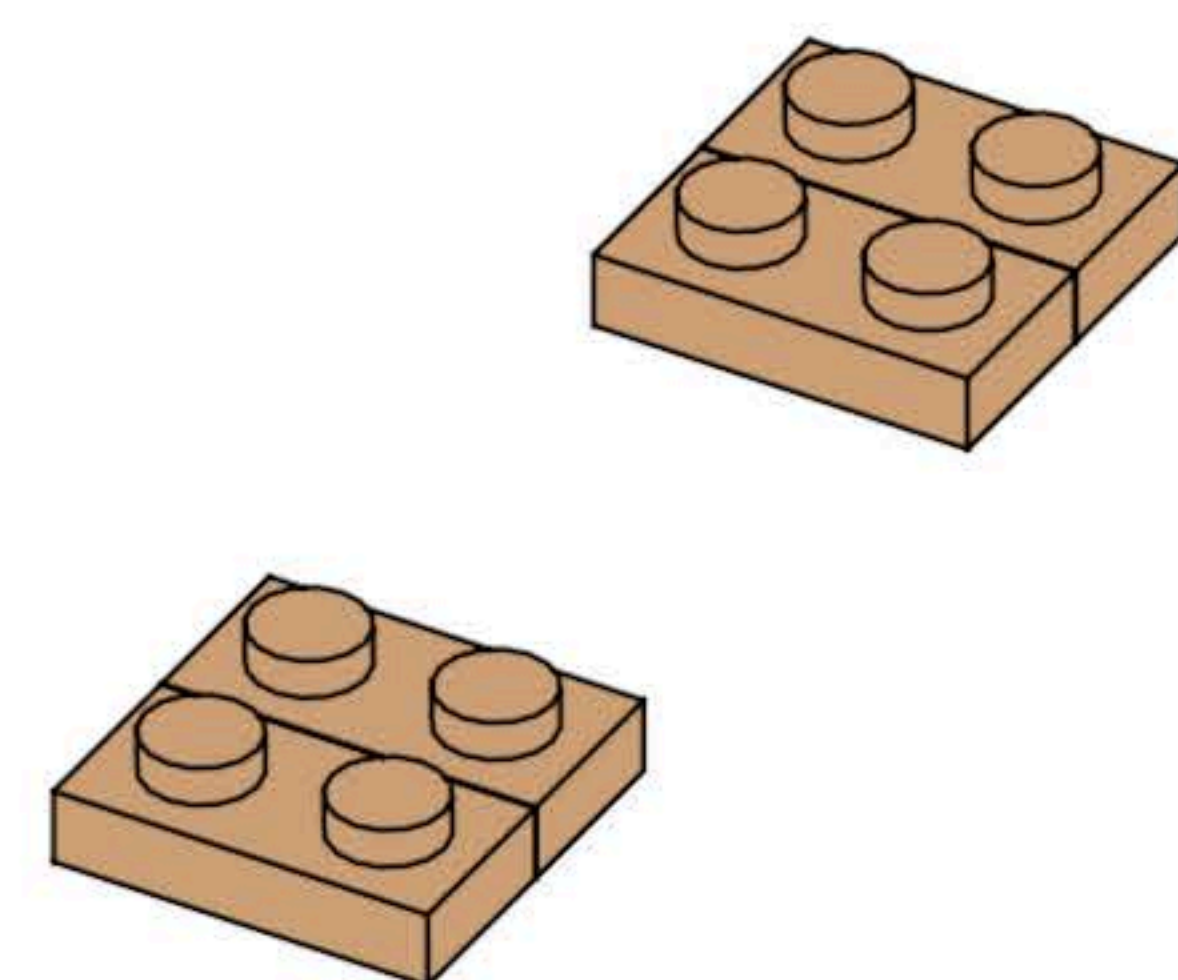
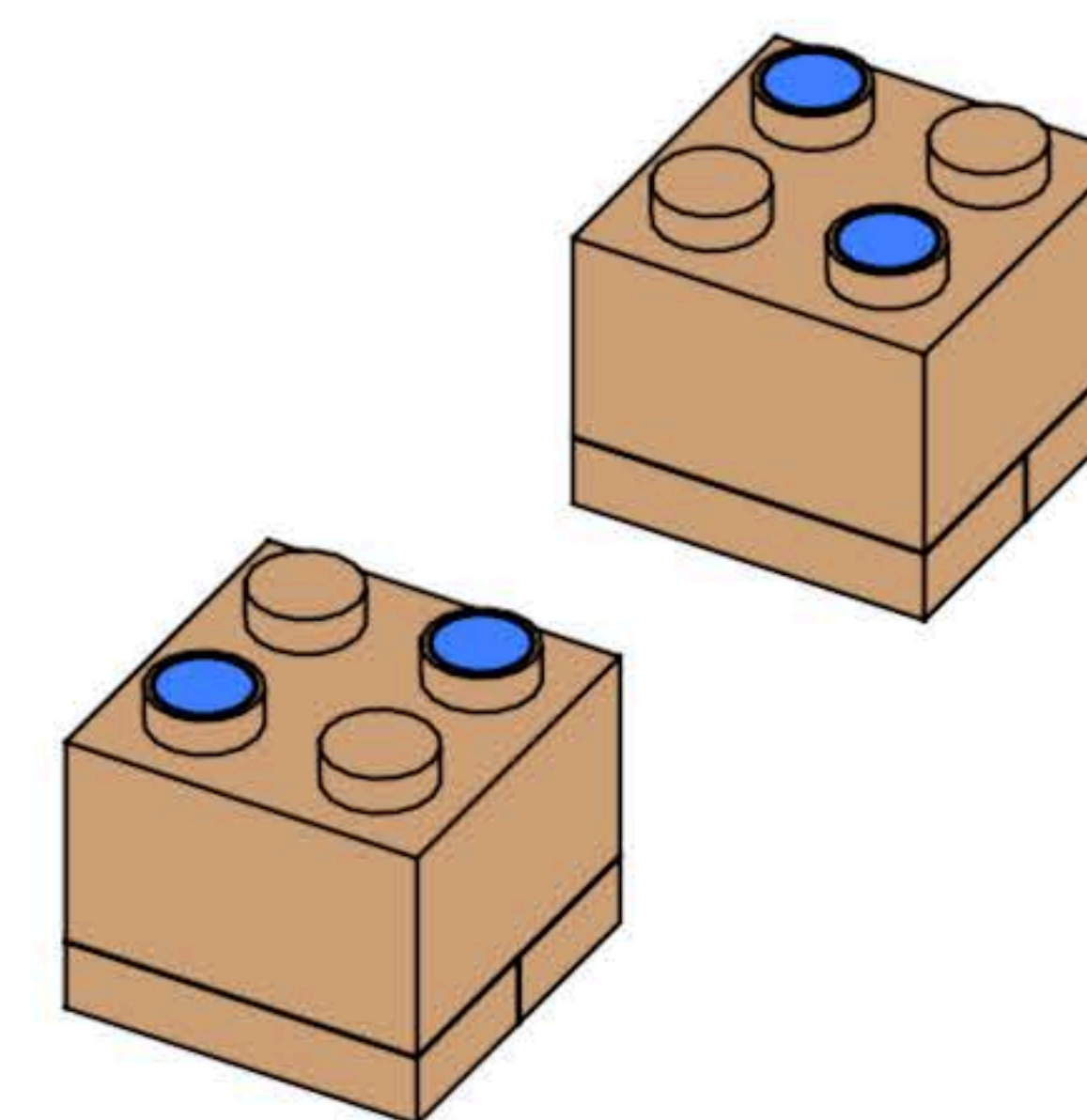
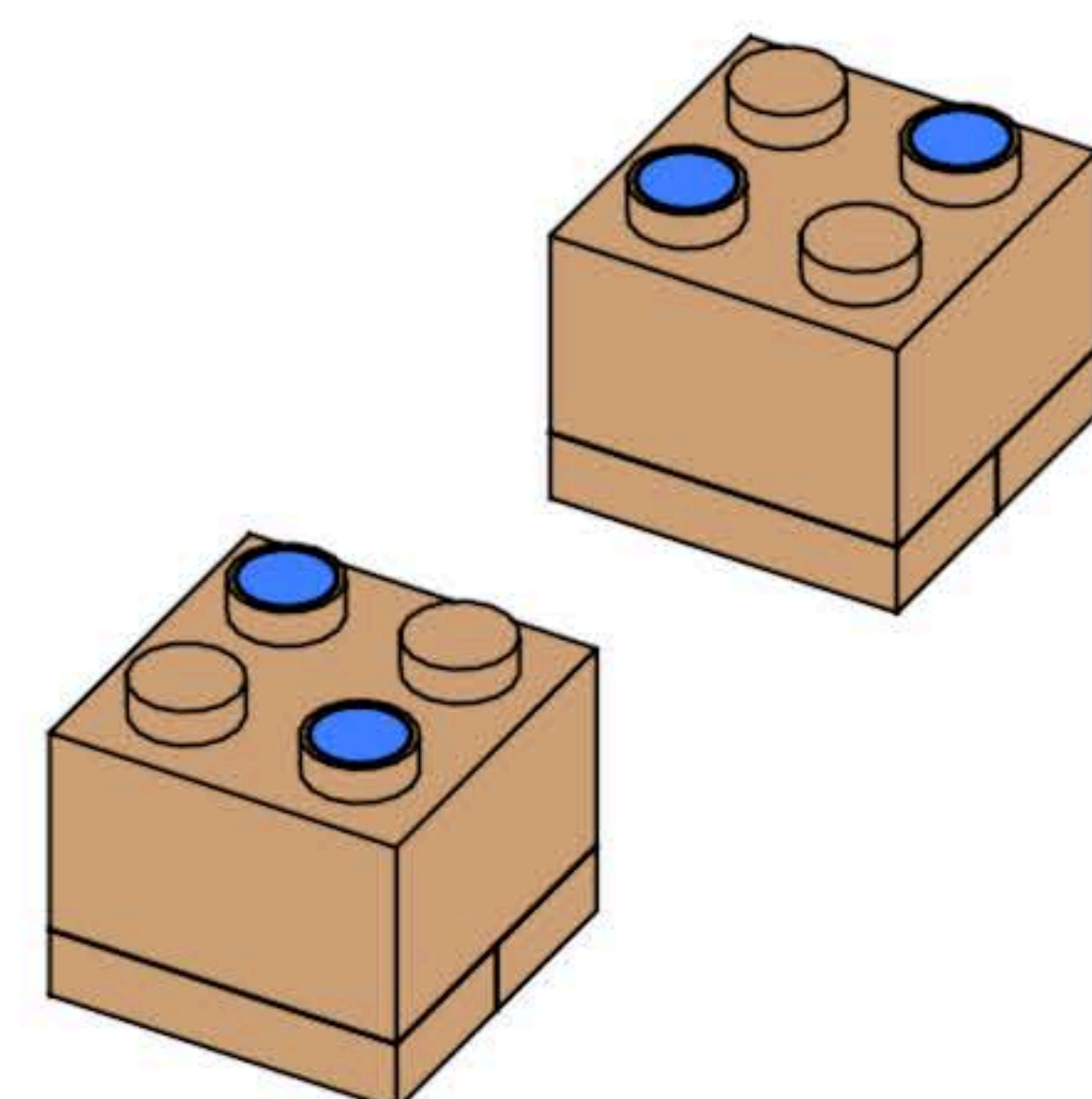

4× Max 2×2

8× Lox-Max

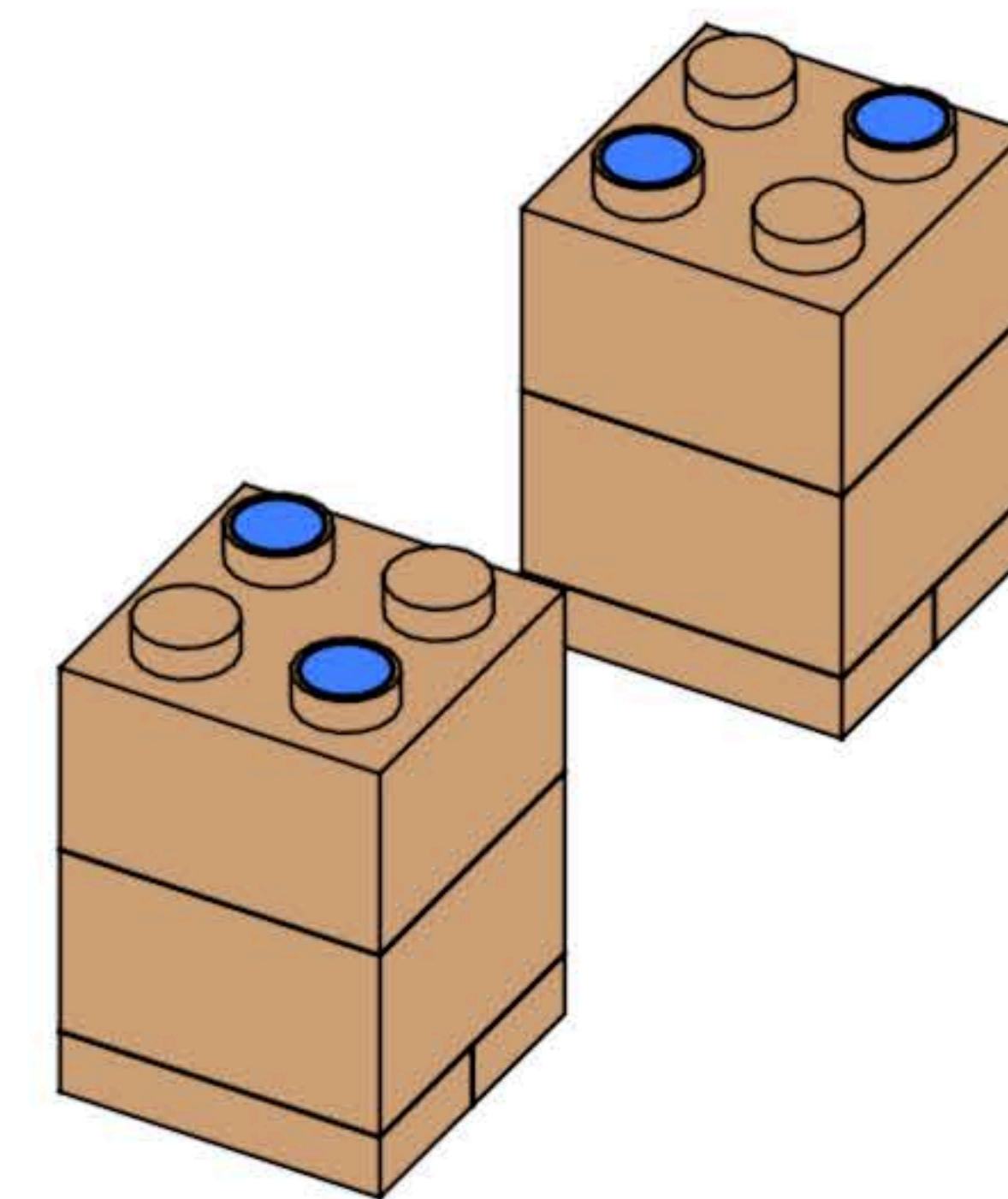
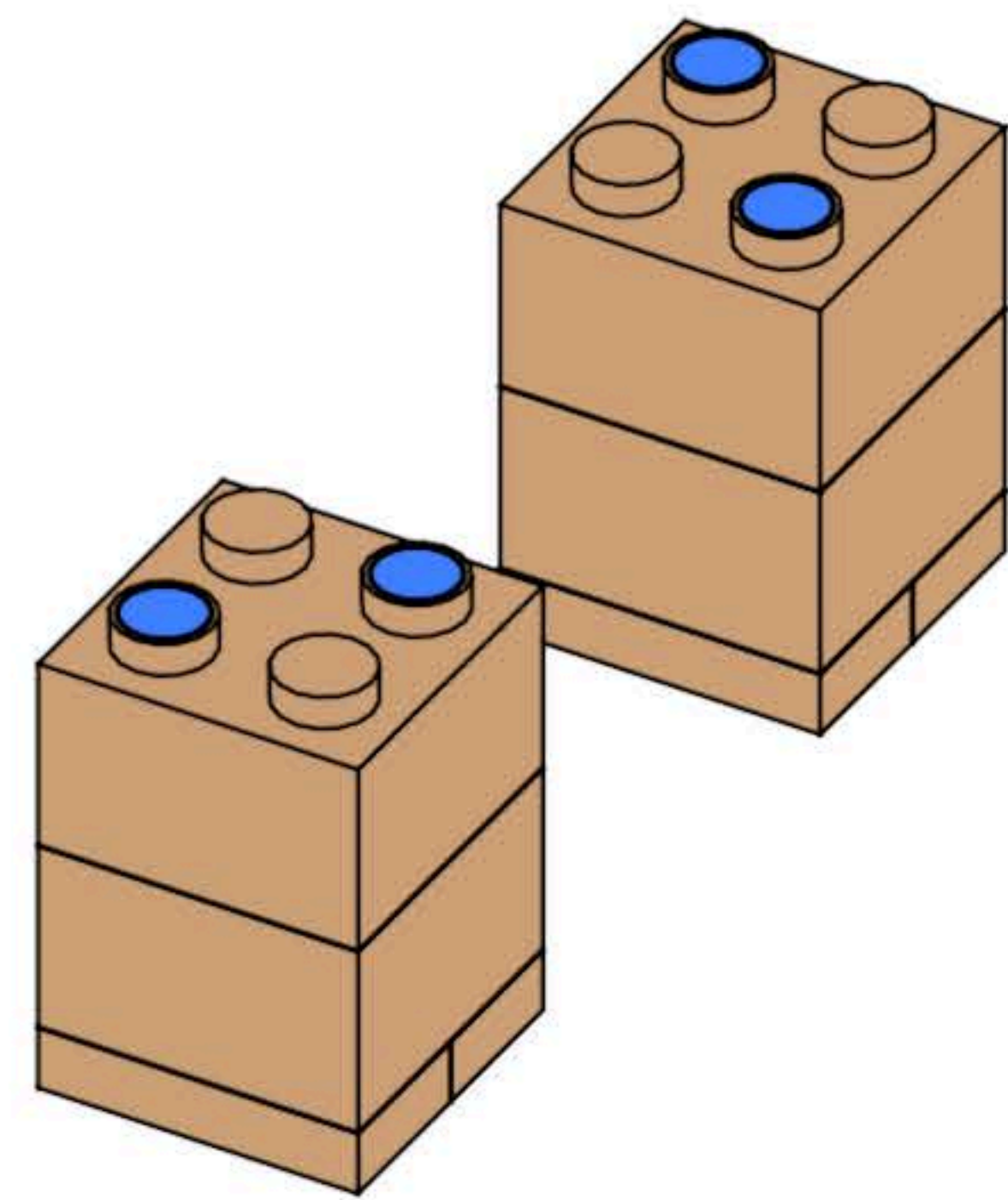

4× Max 2×2

8× Lox-Max

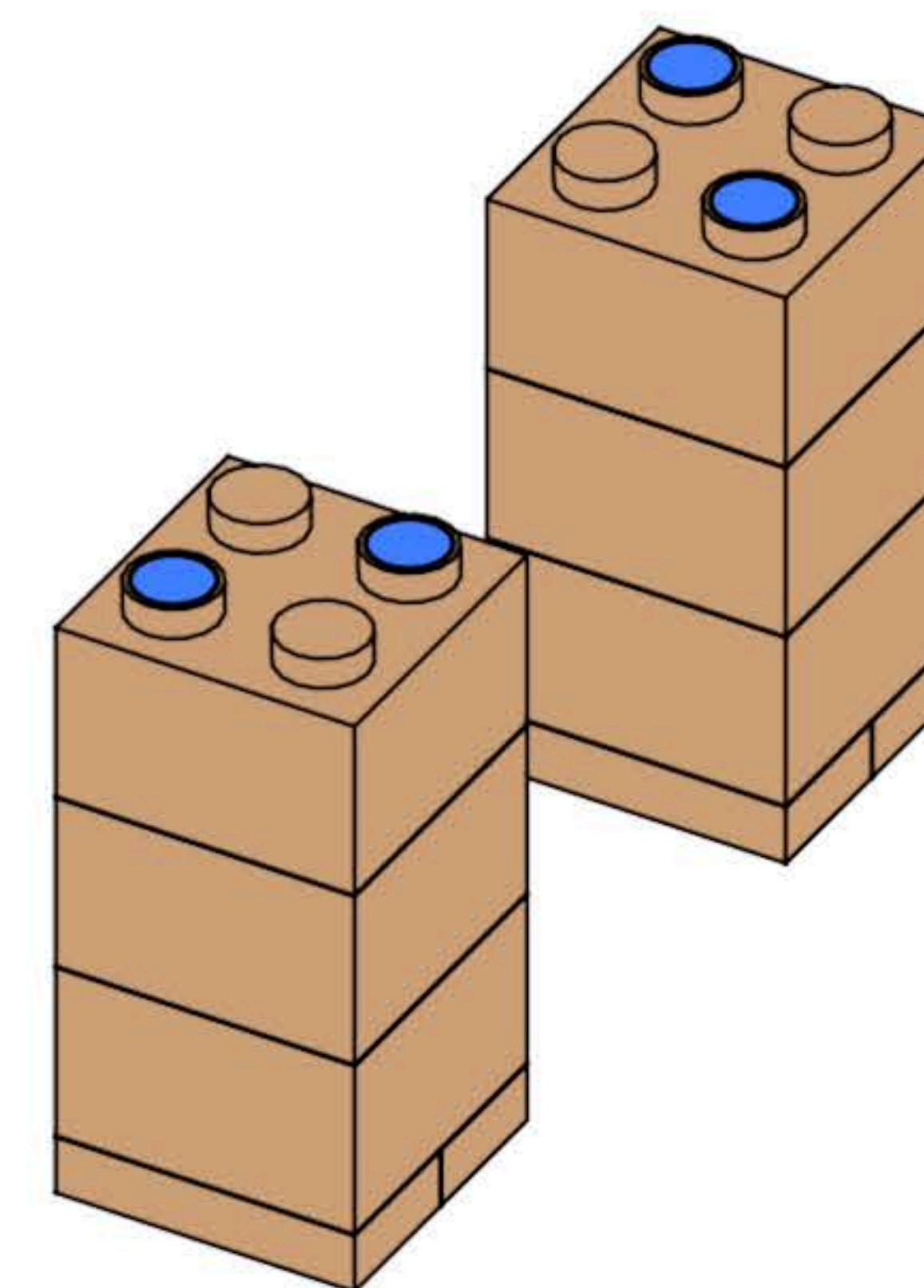
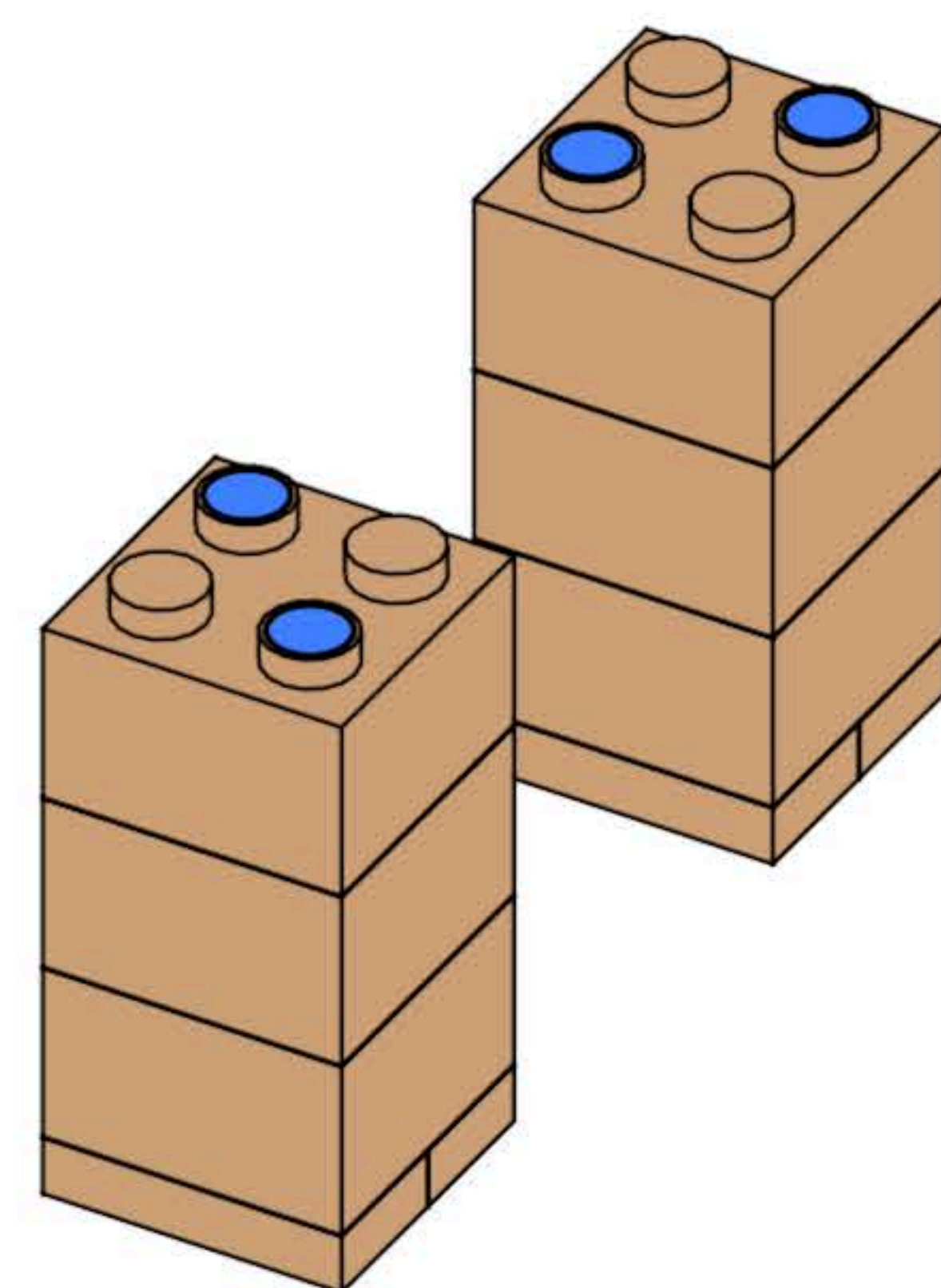

4× Max 2×2

8× Lox-Max

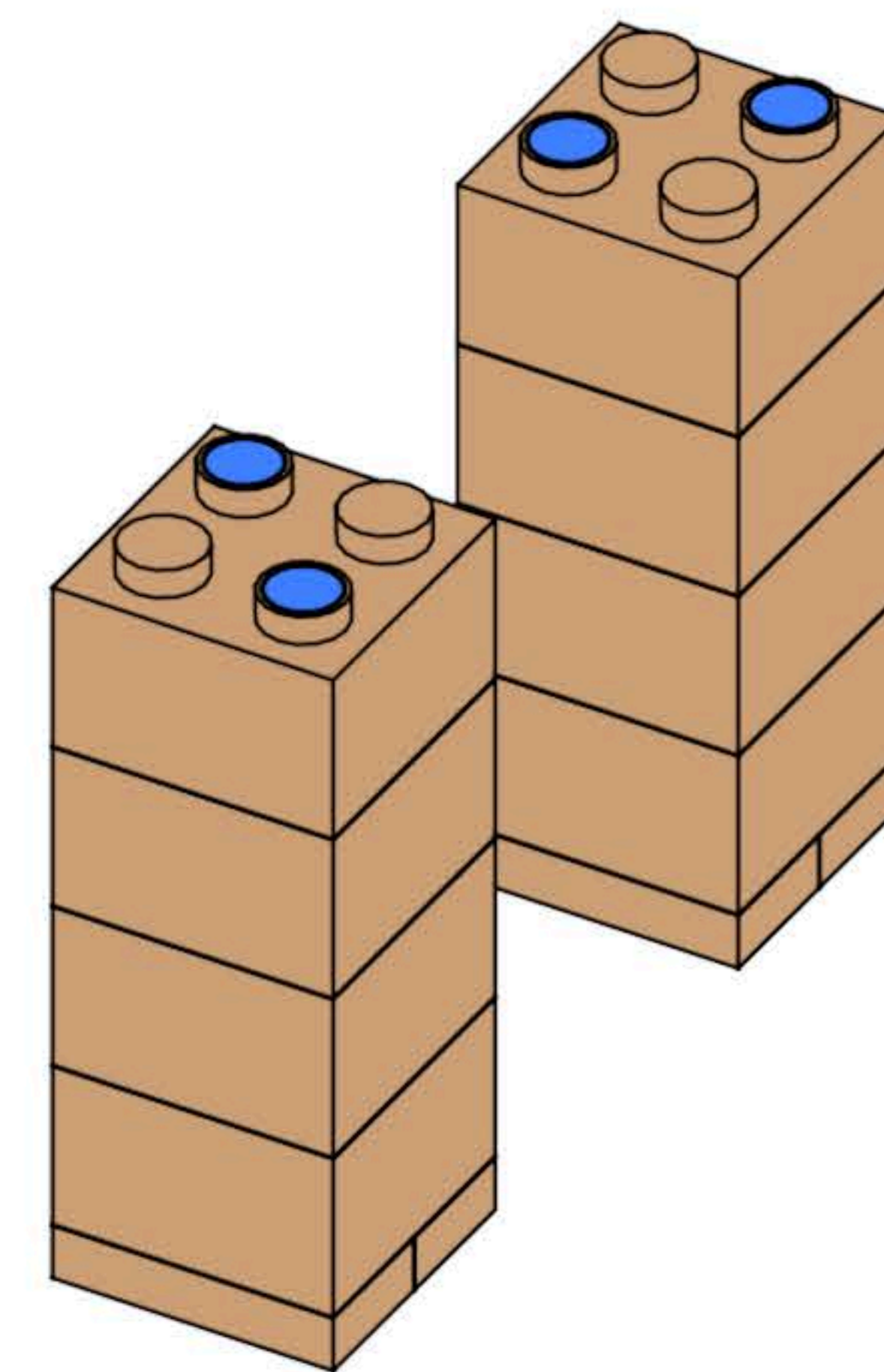
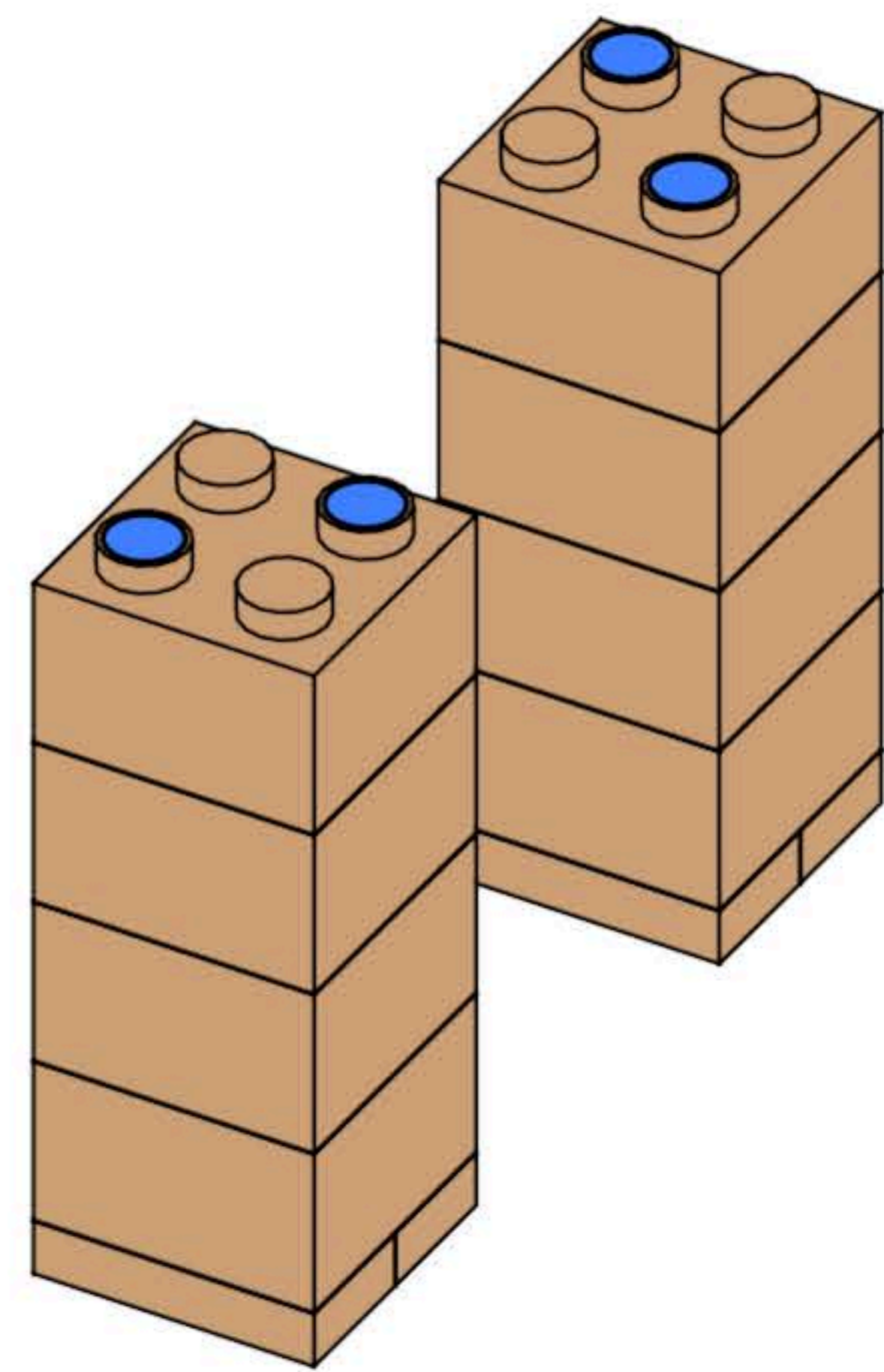

4× Max 2×2

8× Lox-Max

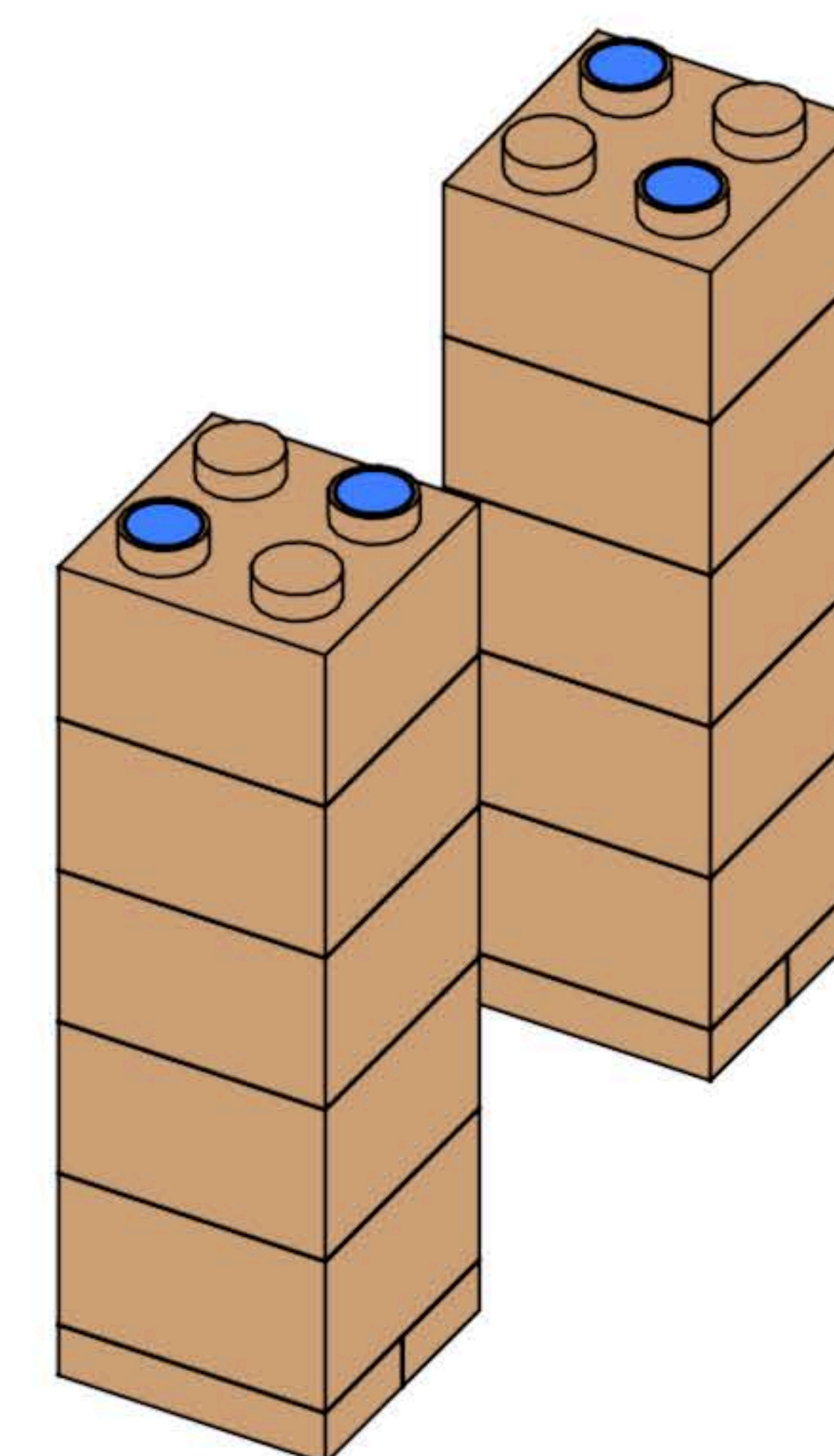
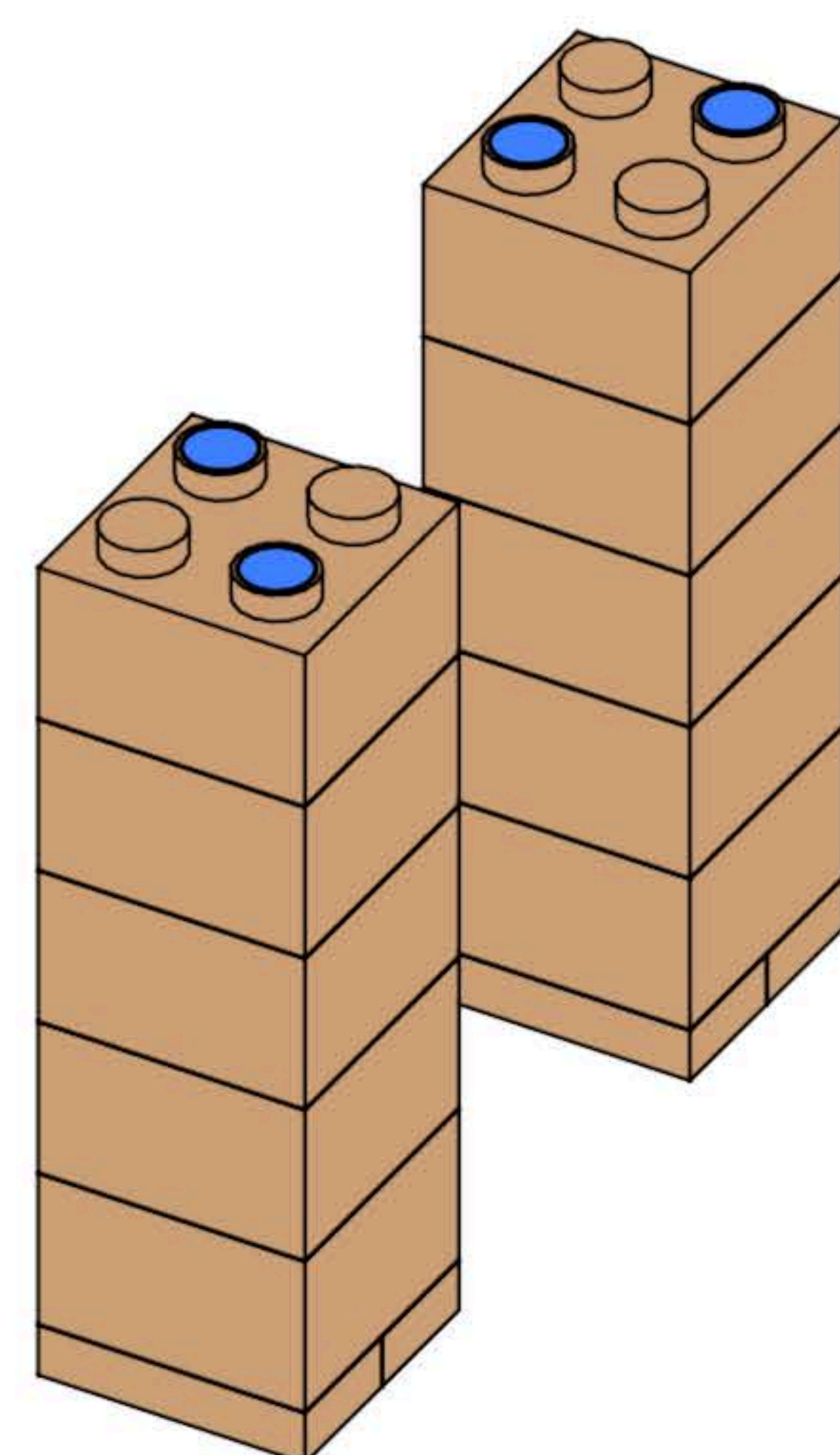

4× Max 2×2

8× Lox-Max

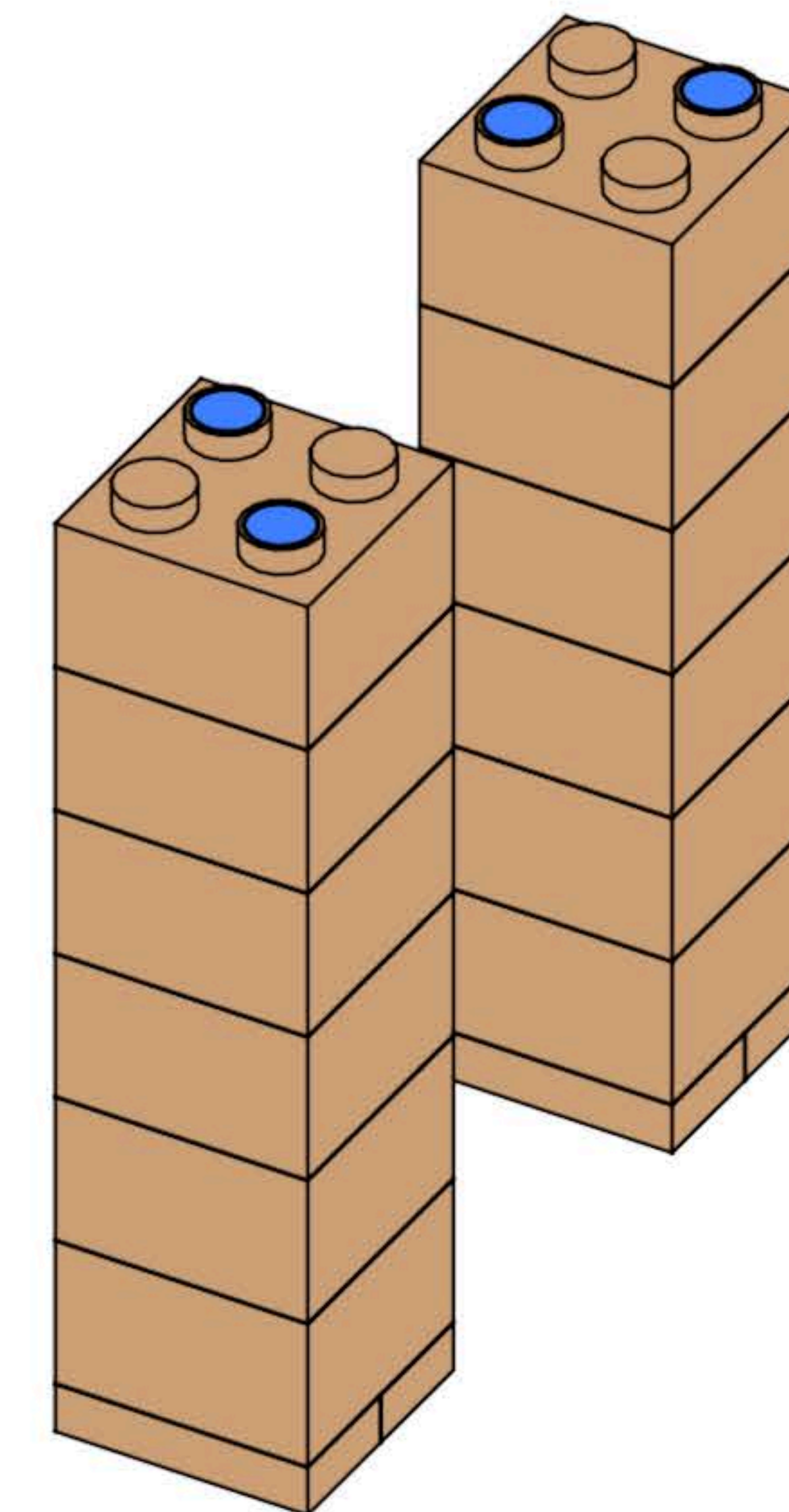
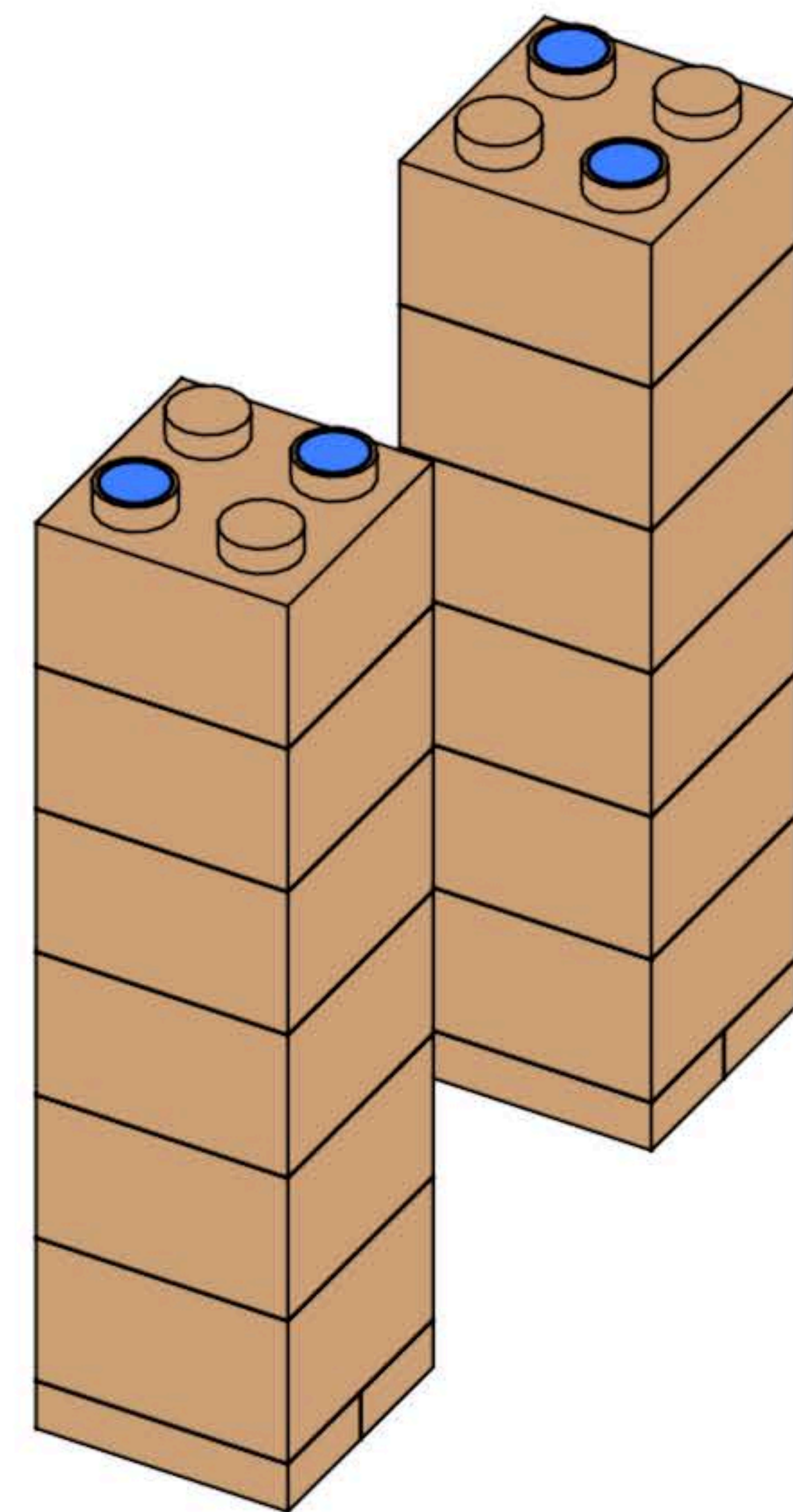

4× Max 2×2

8× Lox-Max

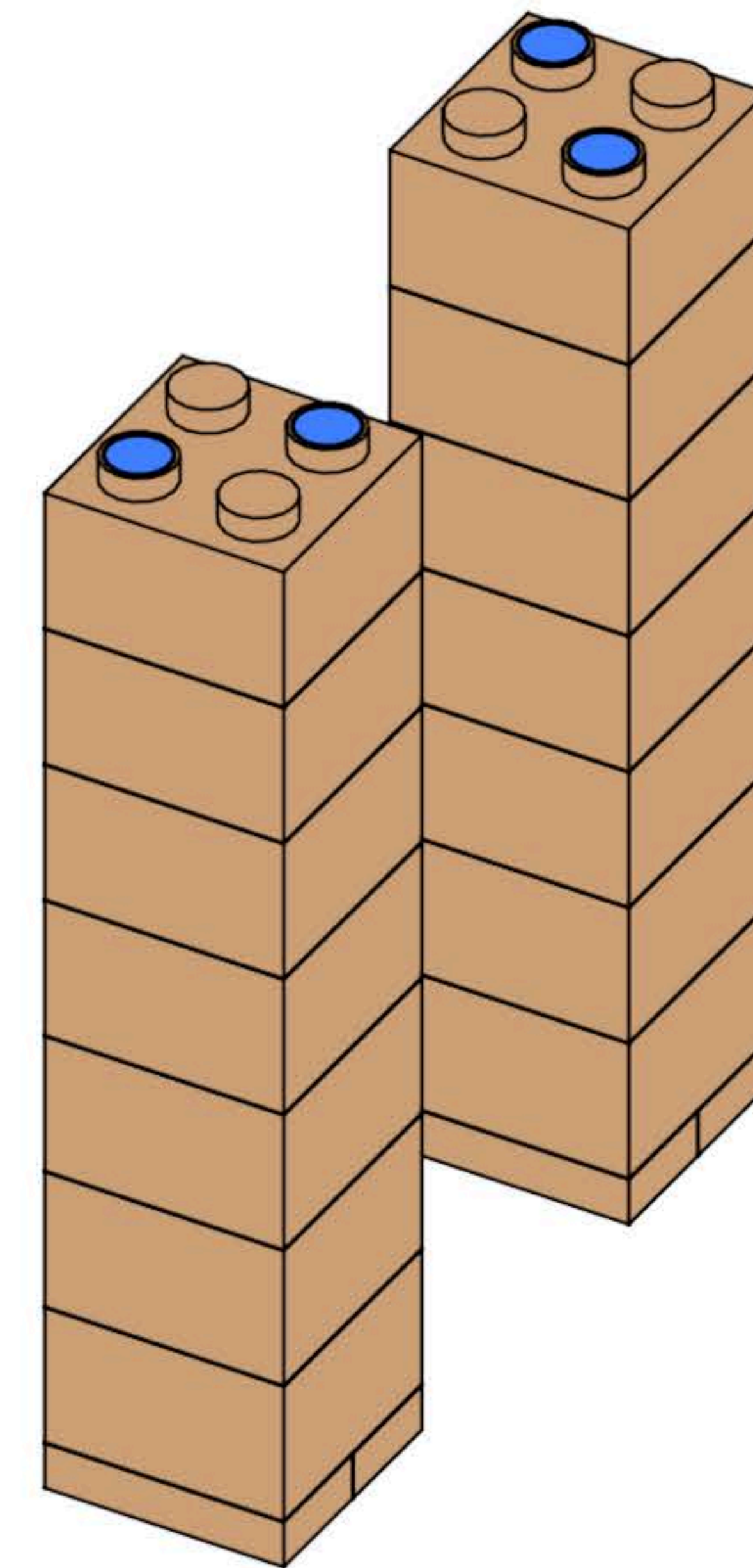
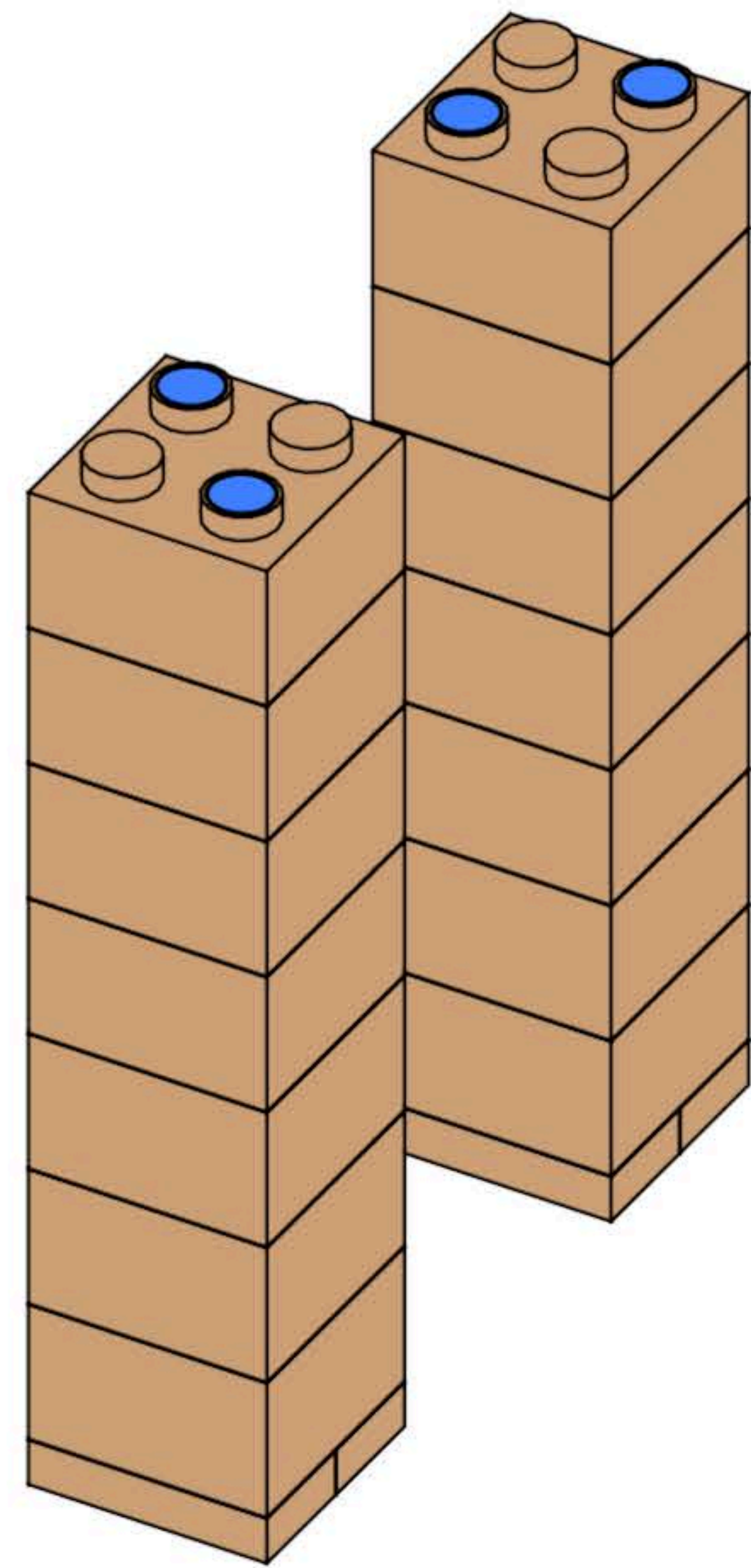

4× Max 1×2

12× Max 2×4

8× Lox-Max

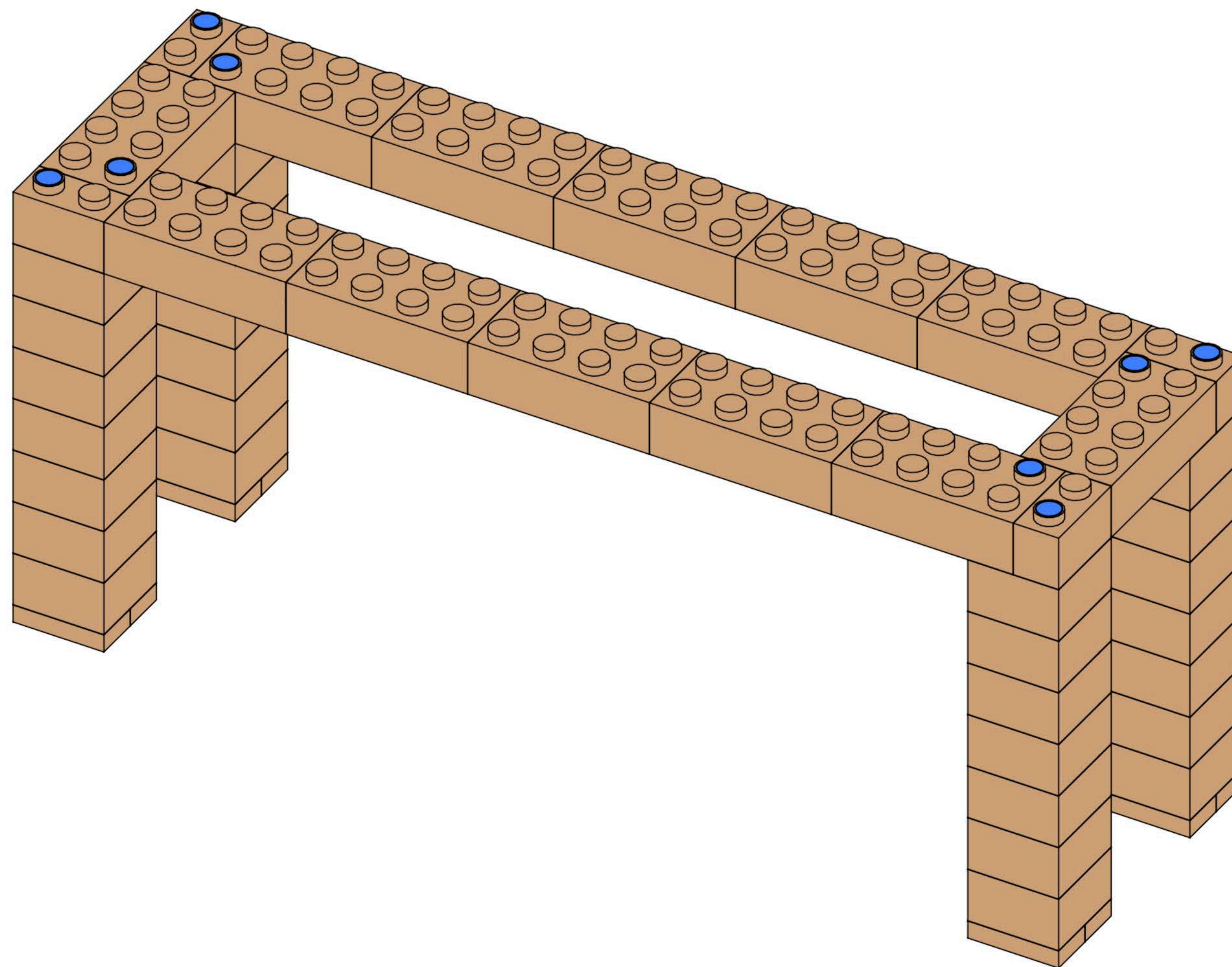

- 4× Max 1×2
- 12× Max 1×4
- 27× Lox-Max

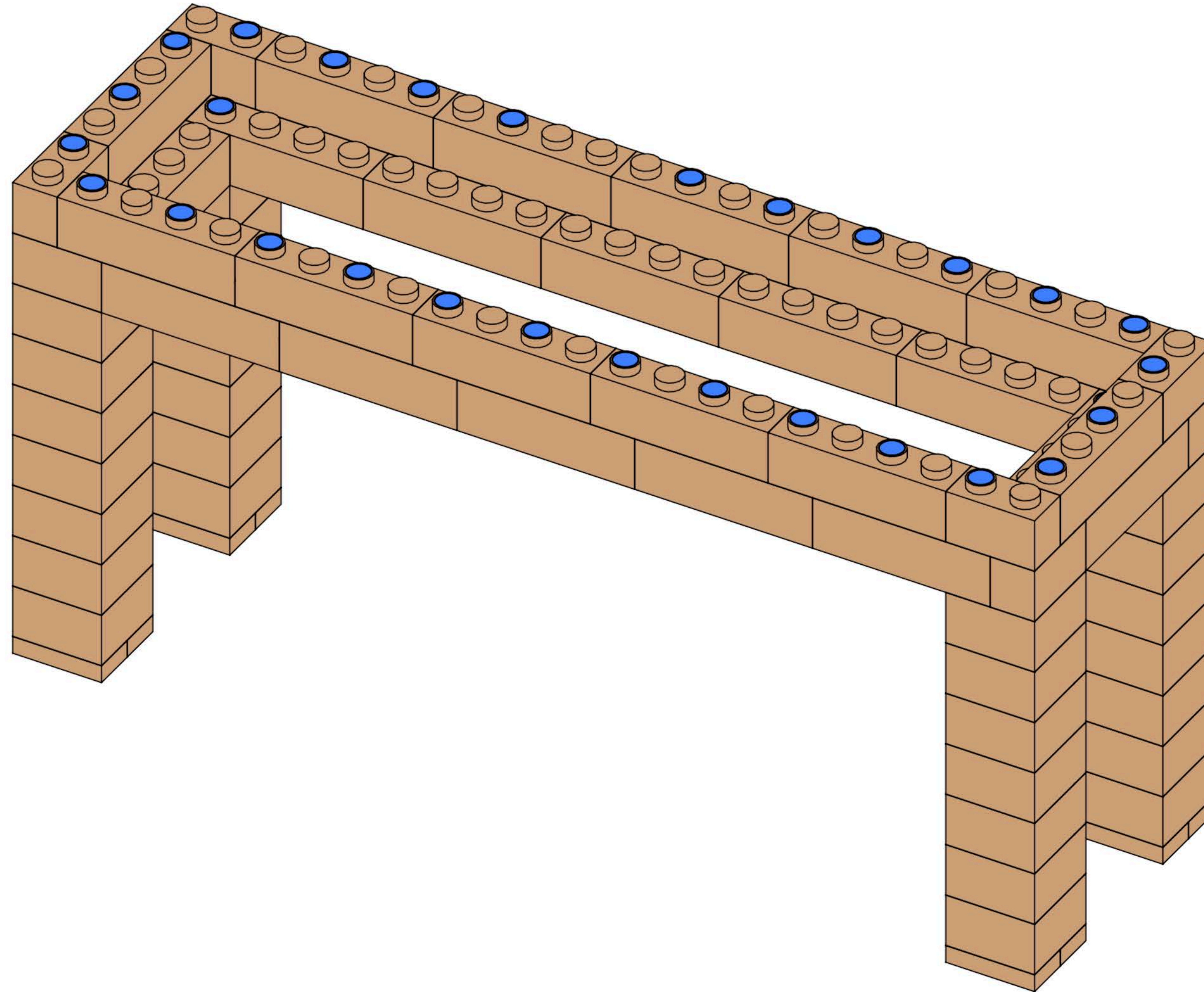

- 4× Max 1×2
- 12× Max 1×4
- 26× Lox-Max

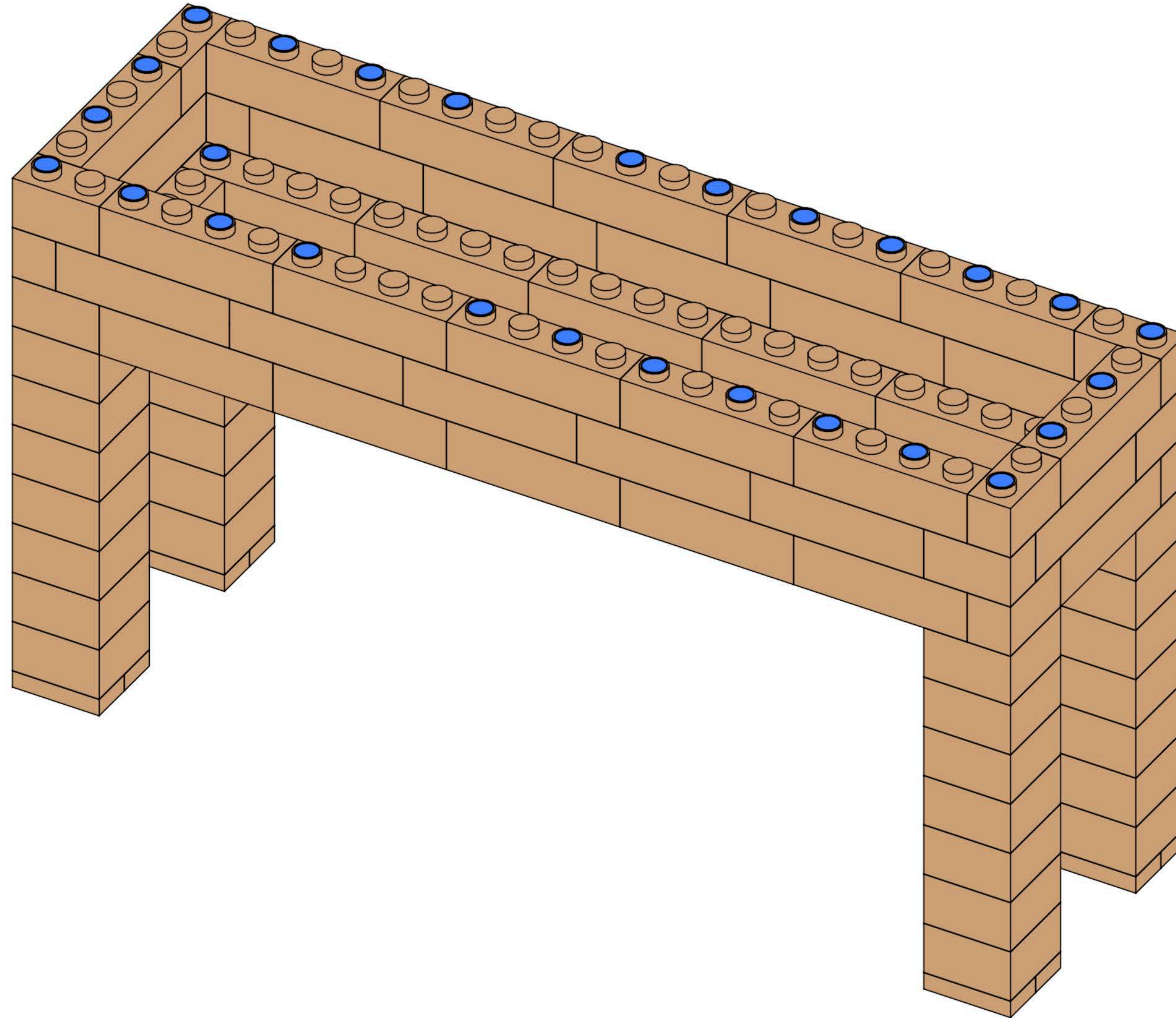

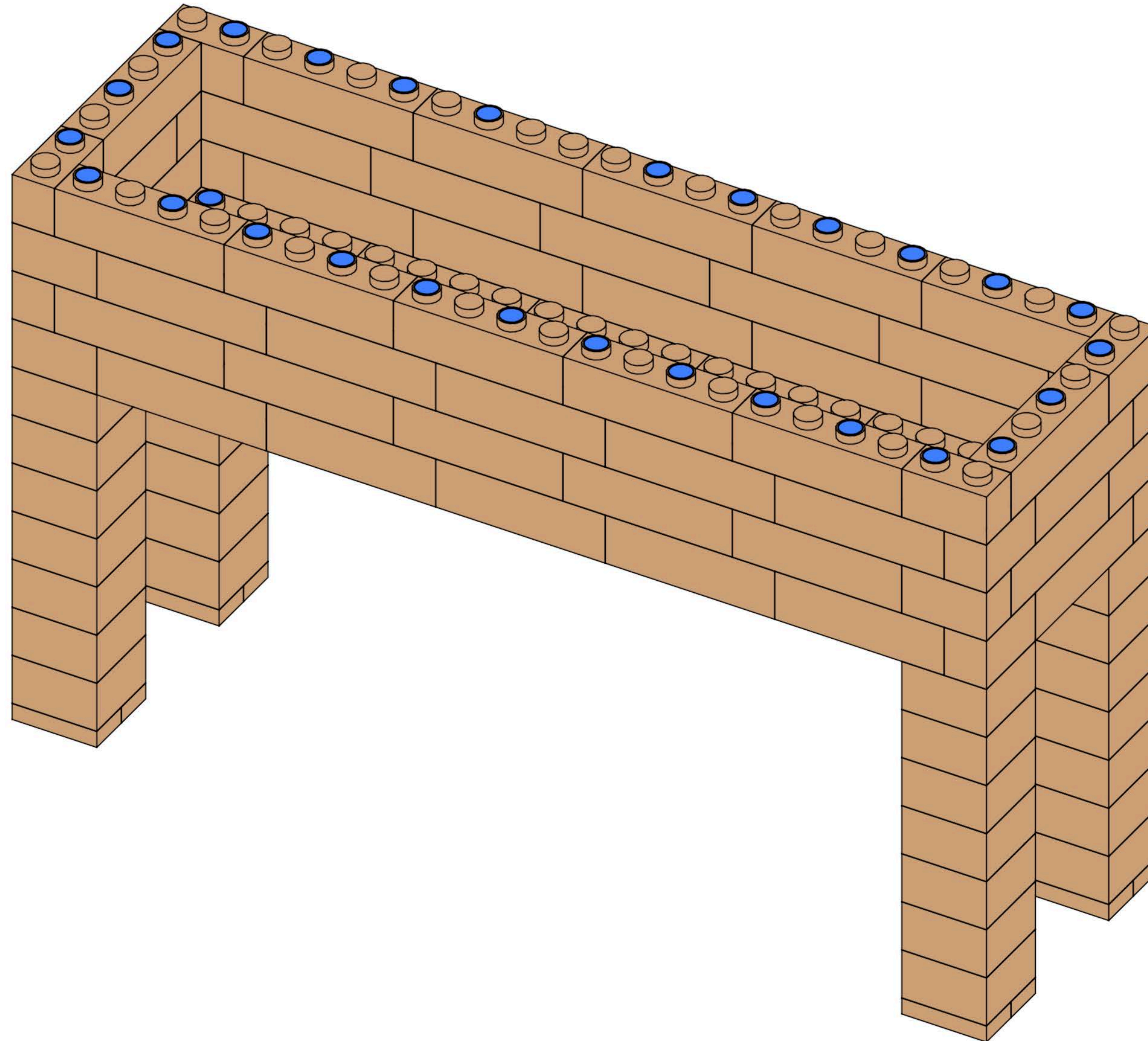

- 4× Max 1×2
- 12× Max 1×4
- 27× Lox-Max

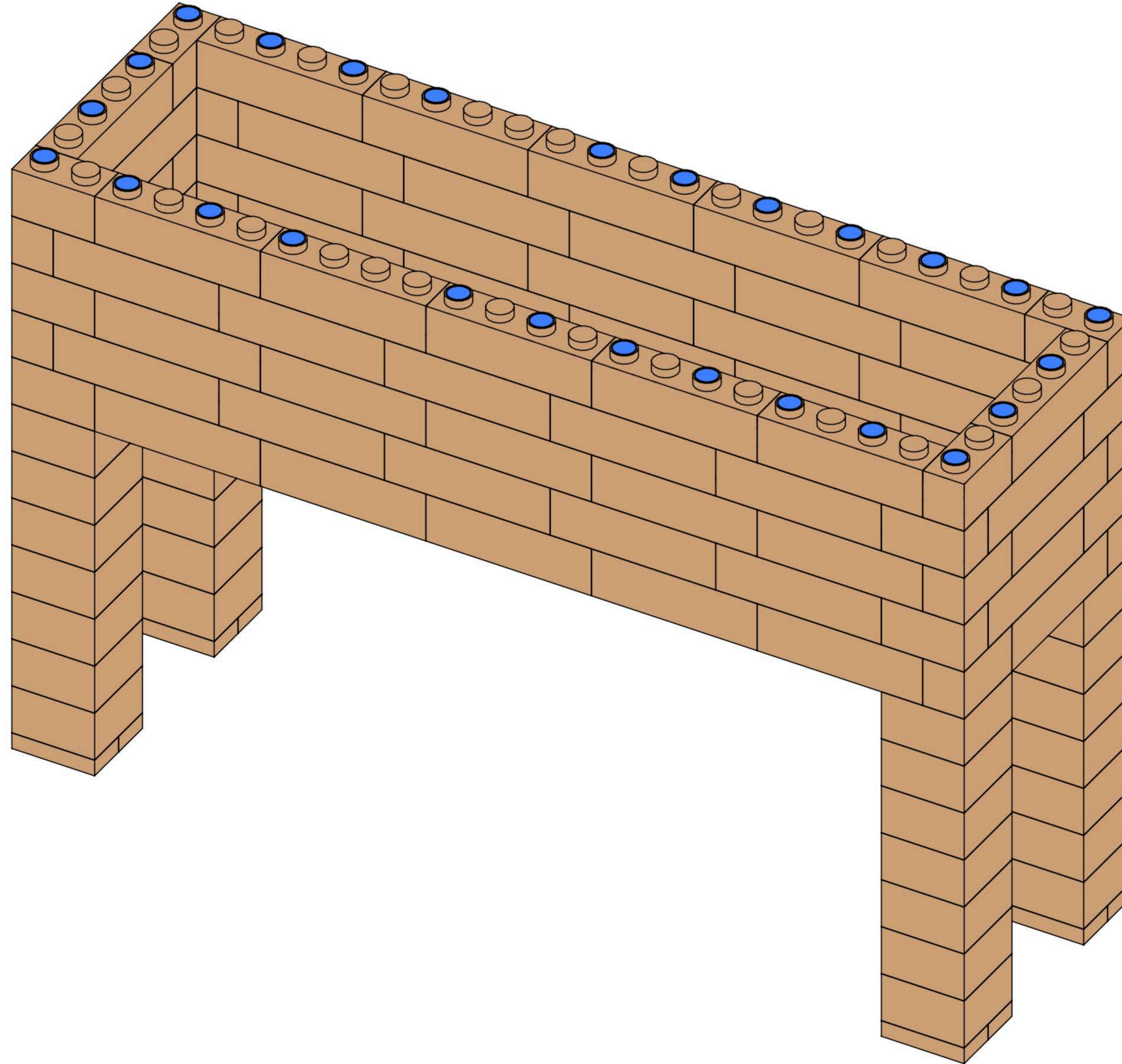

- 4× Max 1×2
- 12× Max 1×4
- 26× Lox-Max

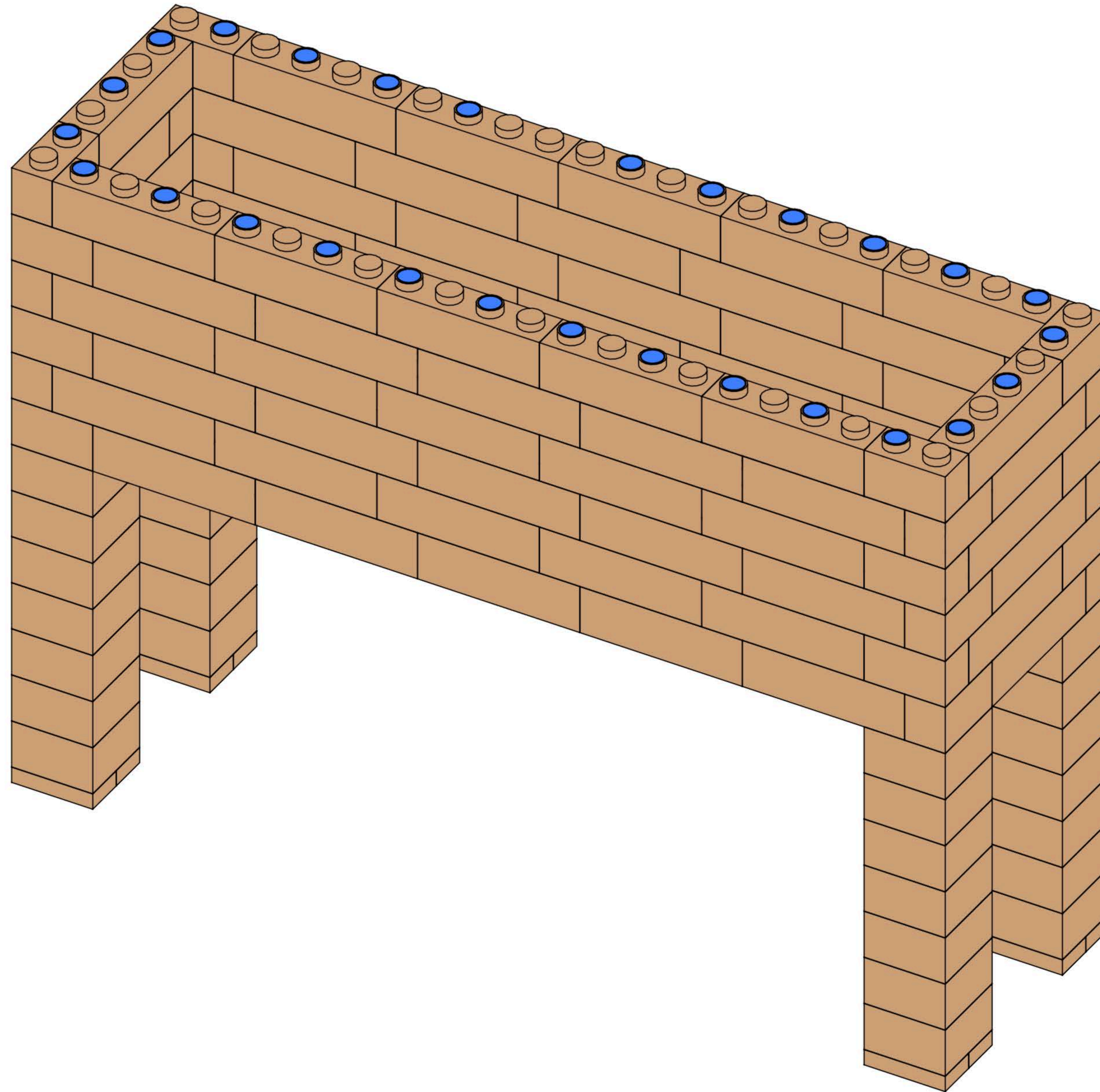

- 4× Max 1×2
- 12× Max 1×4
- 27× Lox-Max

28x Cover 1x2

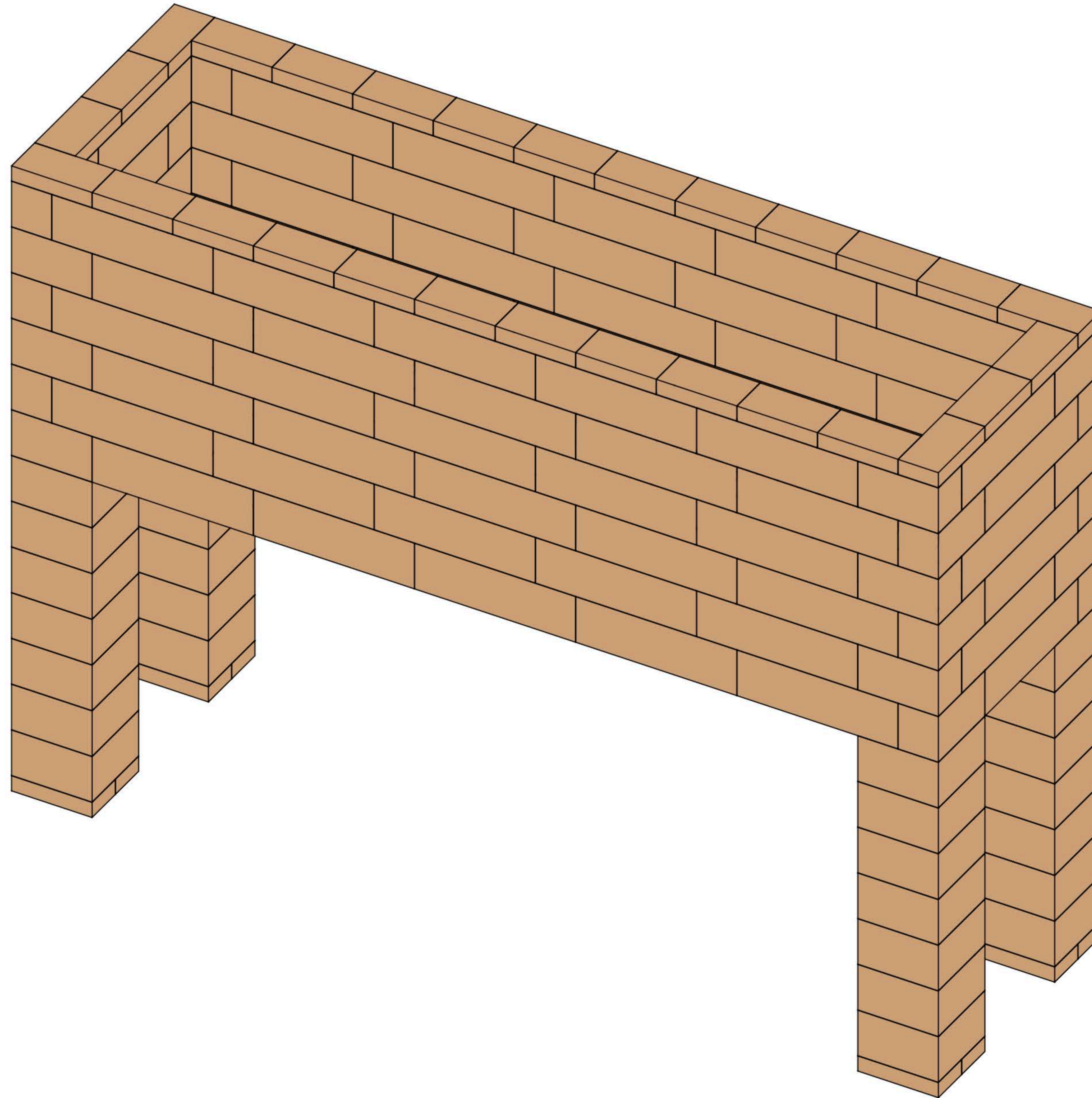

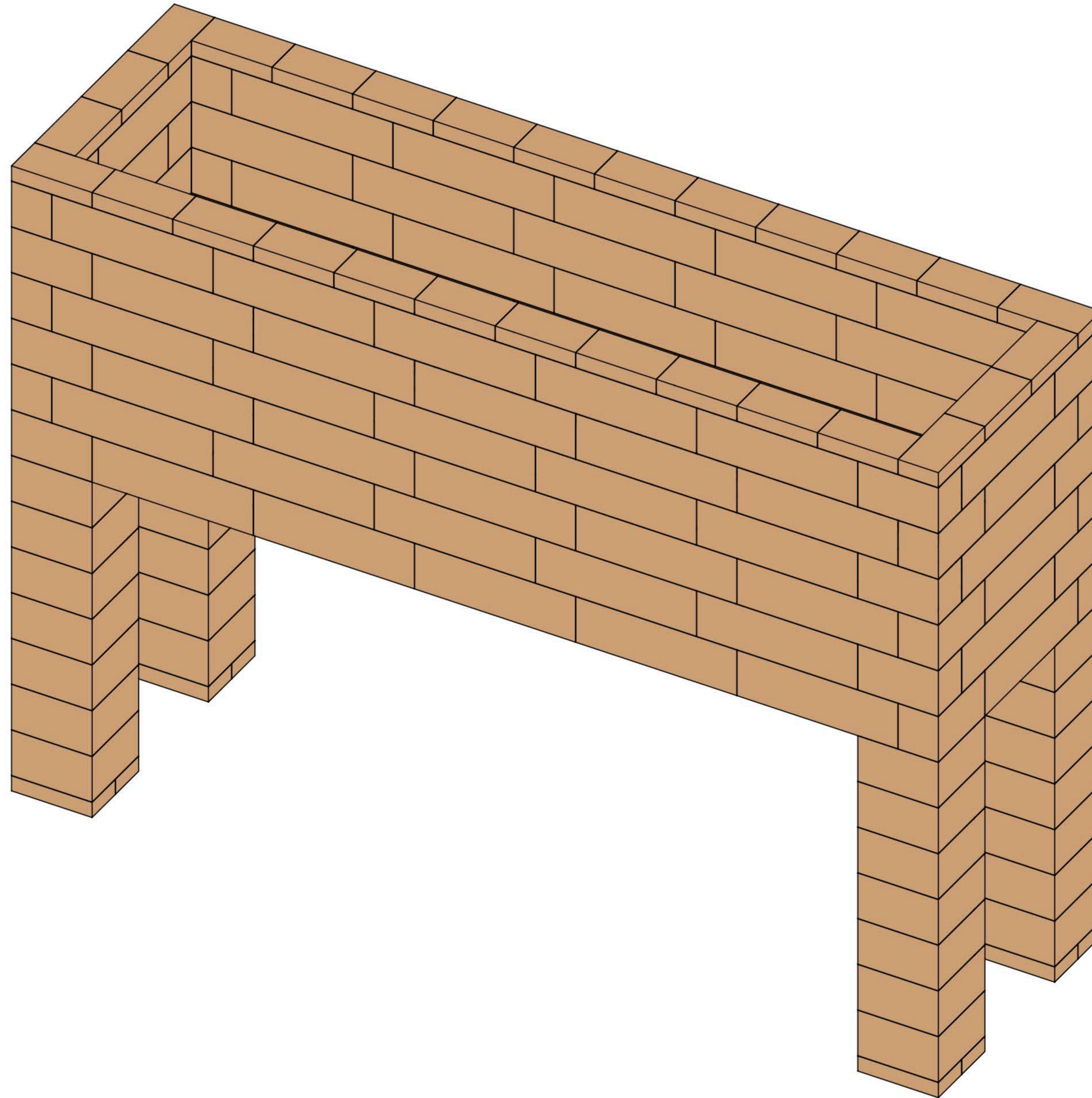

INVENTAR

- 28× Cover 1×2
- 24× Max 1×2
- 60× Max 1×4
- 28× Max 2×2
- 12× Max 2×4
- 8× Oli 1×2
- 197× Lox-Max

SORTIMENT

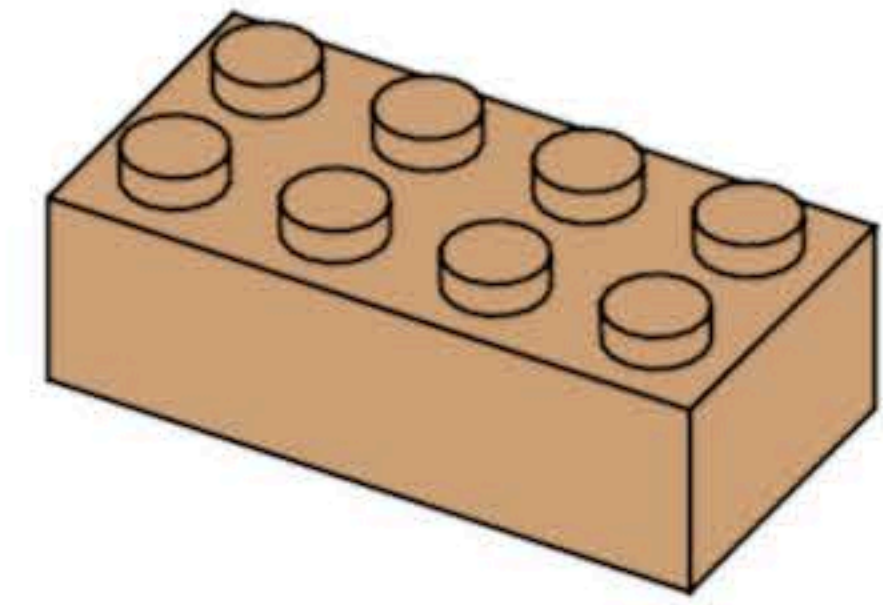

Max 2x4

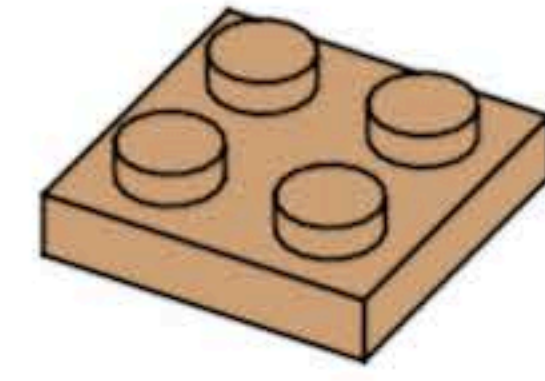

Oli 2x2

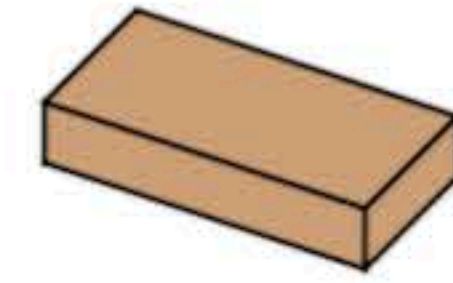

Cover 1x2

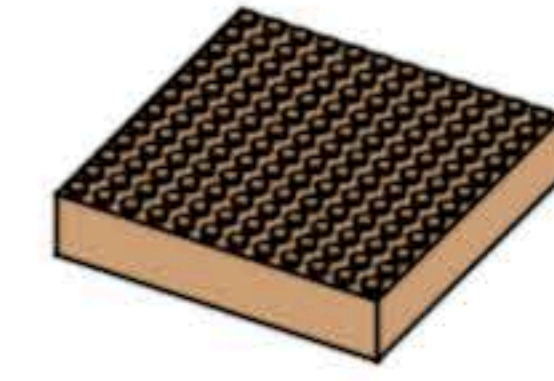

Adapter 2x2

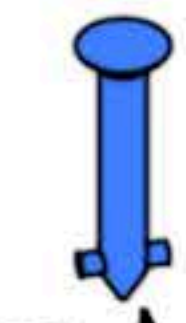

Lox-Max



Haken

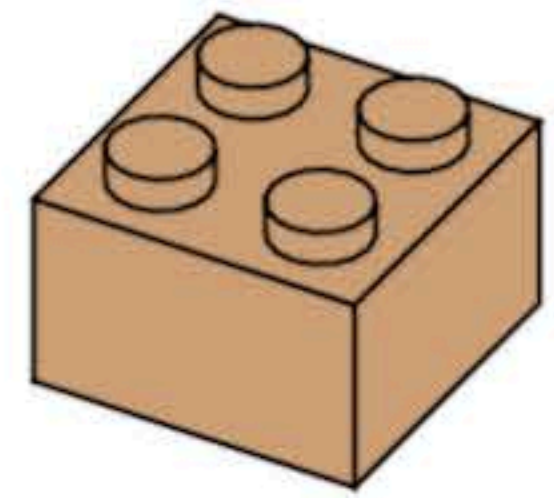

Max 2x2

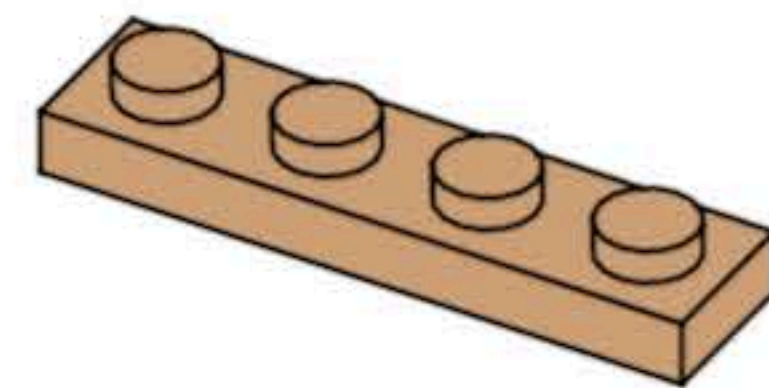

Oli 1x4



Cover 1x1

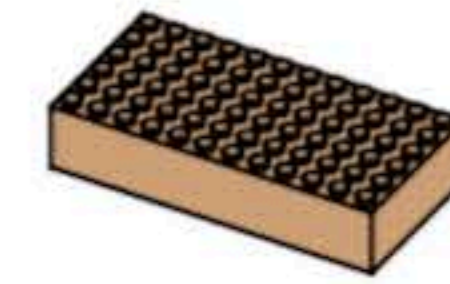

Adapter 1x2



Lox-Oli

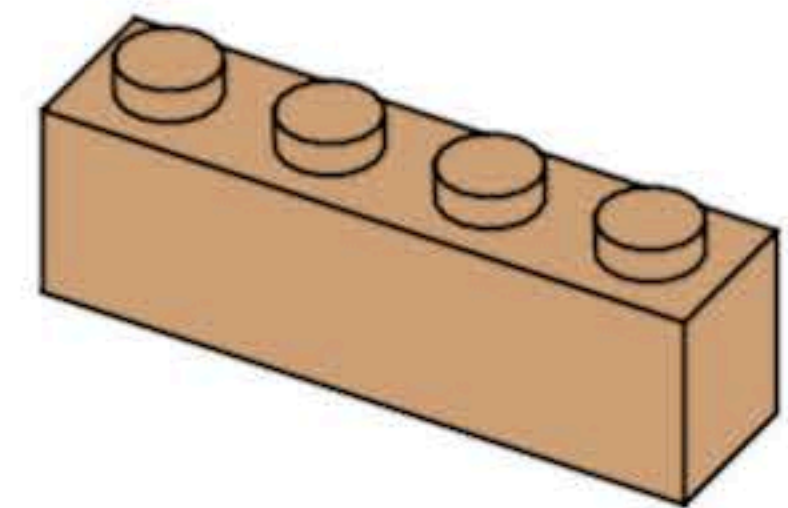

Max 1x4

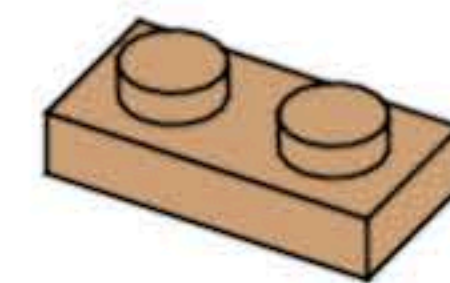

Oli 1x2

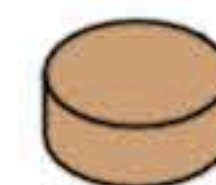

Cover 1x1-rund

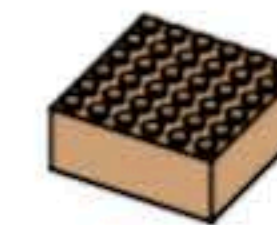

Adapter 1x1



Lox-blind

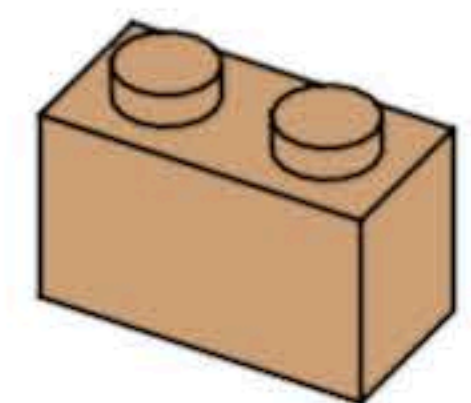

Max 1x2

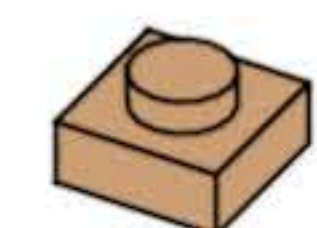

Oli 1x1



Cover 1x1-viertelrund



Lox-Haken

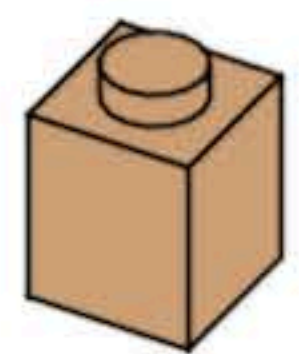

Max 1x1

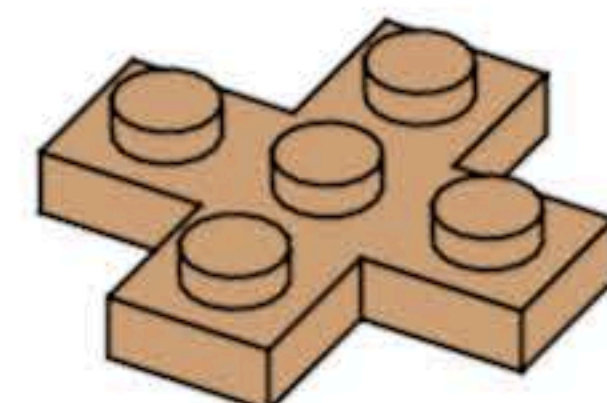

Oli-Cross